USER MANUAL

**Q.HOME CORE
A5**



Table of Contents

1	Information in this Manual	4
1.1	About This Manual	4
1.2	Target Group	4
1.3	Symbols Used in This Manual	4
2	Safety	5
2.1	Intended Use	5
2.2	Safety Precaution	5
2.3	Earth Fault Alarm	6
2.4	Product Safety Labels	6
2.5	Disposal	7
3	Product Description	8
3.1	Q.VOLT Overview	8
3.2	Q.SAVE Overview	9
3.3	Specifications	10
4	Power On/Off	12
4.1	Turning On Q.HOME CORE	12
4.2	Using the Dark Start button	12
4.3	Turning Off Q.HOME CORE	13
5	LED Status	14
6	Using the Q.OMMAND HOME App	15
6.1	Getting Started	15
6.2	Main Menu Overview	17
6.3	Home Tab	17
6.4	Products Tab	18
6.5	Energy Tab	20
6.6	Changing the User Information	20
6.7	Viewing the Installation Information	21
6.8	Light Mode/Dark Mode Setting	21

7	Operating Mode	22
7.1	ON-Grid Mode	22
7.2	Off-Grid Mode	23
7.3	Seamless Transfer	24
8	Features	25
8.1	Protection	25
8.2	Power Derating	25
8.3	Overload Operation	25
8.4	Power Quality Response	26
8.5	Battery Management	27
8.6	Demand Response Modes (DRMS)	28
8.7	Dark Start	28
9	Maintenance	29
9.1	Cleaning the Cover	29
10	Full Warranty	30

1 Information in this Manual

1.1 About This Manual

This is the installation manual for Q.HOME CORE A5. Please read this installation and user manual carefully before installing and operating Q.HOME CORE A5. It contains important safety instructions. The warranty will be void if you fail to follow the instructions in this manual.

1.2 Target Group

Electricians and qualified technicians who are allowed to install and to connect electrical systems.

1.3 Symbols Used in This Manual



WARNING

This symbol indicates a hazardous situation which could result in death or serious injury, if not avoided.



CAUTION

This symbol indicates a hazardous situation which could result in minor or moderate injury, if not avoided.



Prohibited.

Note

This indicates valuable tips for installation of the product.

2 Safety

The safety section may not include all regulations for your locale; personnel working with Q.HOME CORE A5 must review applicable federal, state and local regulations and the industry standards regarding this product.

2.1 Intended Use

Q.HOME CORE A5 is designed for residential use only. It should not be used for commercial or construction area. It is a single-phase, Grid-connected system of solar energy sources and Li-Ion Battery energy storage.

Q.HOME CORE A5 uses solar energy power connected to the input/output terminal installed on the side of the device in order to:

- charge the Li-Ion Battery energy storage,
- provide a supply to the household load, and
- convert direct current (DC) electricity of the Battery to alternating current (AC) to discharge as household single-phase load or electric system.

This device should not be used for any purpose other than the purpose described in this installation manual. Any substitute use of this device, random change in any of its parts, and use of components other than sold or recommended by Qcells will nullify the product's guarantee.

For example, Qcells Li-Ion Battery energy storage should not be replaced by other manufacturer's Battery storages. For further information on proper use of this device, contact the Qcells Service-Hotline.

2.2 Safety Precaution

The following safety precautions and the warning messages described in this section must be observed. If any of the following precautions are not fully understood, or if you have any questions, contact the customer support for guidance.



- All work on the ESS and electrical connections must be carried out by qualified personnel only.
- High voltages in power conditioning circuits. Lethal hazard of electric shock or serious burns. Wear rubber gloves and protective clothing (protective glasses and boots) when working on high voltage/high current systems such as the inverter and battery systems.
- This product provides a safe source of electrical energy when operated as intended and as designed. But a potentially hazardous circumstance such as excessive heat or electrolyte mist may occur due to improper operating conditions, damage, misuse and/or abuse.
- Do not connect or disconnect PVs, batteries, and grid connectors with the power on. Otherwise, it may generate electric arcs or sparks, causing fire or injury.
- Do not open the enclosure while the inverter is operating. Touching inner components under running condition may lead to electric shock, causing death or serious injury.
- Before maintenance, turn off the equipment for at least 5 minutes and strictly comply with the safety precautions stated in this manual.

 **CAUTION**

- This product is intended to be used for PV source inputs and residential home grids (AC 230 V). If not used as intended, the protection provided by the equipment may be impaired.
- This product is designed appropriate for two-PV string structure. Therefore, the PV string 1 and PV string 2 must be connected to PV input 1 and PV input 2, respectively. Do not split one PV string output for connecting it into the PV input terminal 1 and input terminal 2.
- After disconnecting the inverter from the battery pack or PV, wait 5 minutes to discharge the inverter.
- Do not touch the PV cable when the product is connected to the PV arrays. When the photovoltaic array is exposed to light, it supplies DC voltage to the product.
- In case of short circuit, high-voltage components inside the inverter may influence the product or other properties. Cover the product or take other precautions to prevent metal objects from entering inside during installation and wiring.

2.3 Earth Fault Alarm

When an earth fault occurs, the inverter stops operation and the buzzer operates for 2 minutes, and the earth fault code is notified to the installer and administrator.

Note: This feature is only supported on models released in Australia.

2.4 Product Safety Labels



Wear eye protection at all times (installation, maintenance, etc.)



Follow the instruction in this manual for service and replacement.



Caution: Risk of Electric Shock
Alternating current (AC) and direct current (DC) sources are connected to this device. To prevent risk of electric shock during installation or maintenance, ensure that all AC and DC connections are disconnected.



Caution: Hot Surface
Metallic parts of enclosure may be hot during operation.



Caution: Risk of Electric Shock
Hazardous voltage is still present 5 minutes after all power sources have been disconnected. Wait for at least 5 minutes before maintenance to prevent electric shock.



Warning: Explosion
Do not expose to heat or flame. Keep away from flammable substances.



Warning: Corrosive Substances Leaking
Do not disassemble or modify the battery. Otherwise, corrosive substances may leak.

2.5 Disposal

Disposal of Q.VOLT



- When this crossed-out wheeled bin symbol is attached to a product, it means the product is covered by the European Directive 2002/96/EC.
- All electrical and electronic products should be disposed of separately from the municipal waste stream via designated collection facilities appointed by the government or the local authorities.
- The correct disposal of your old appliance will help prevent potential negative consequences for the environment and human health.
- For more detailed information about disposal of your old appliance, please contact your city office, waste disposal service or the shop where you purchased the product.

Disposal of Q.SAVE



- When this crossed-out wheeled bin symbol is attached to batteries/accumulators of your product, it means they are covered by European Directive 2006/66/CE.
- This symbol may be combined with chemical symbols for mercury(Hg), cadmium(Cd) or lead(Pb) if the battery contains more than 0.0005% of mercury, 0.002% of cadmium or 0.004% of lead.
- All batteries/accumulators should be disposed separately from the municipal waste stream via designated collection facilities appointed by the government or the local authorities.
- The correct disposal of your old batteries/accumulators will help to prevent potential negative consequences for the environment, animal and human health.
- For more detailed information about disposal of your old batteries/accumulators, please contact your city office, waste disposal service or the shop where you purchased the product.

3 Product Description

3.1 Q.VOLT Overview

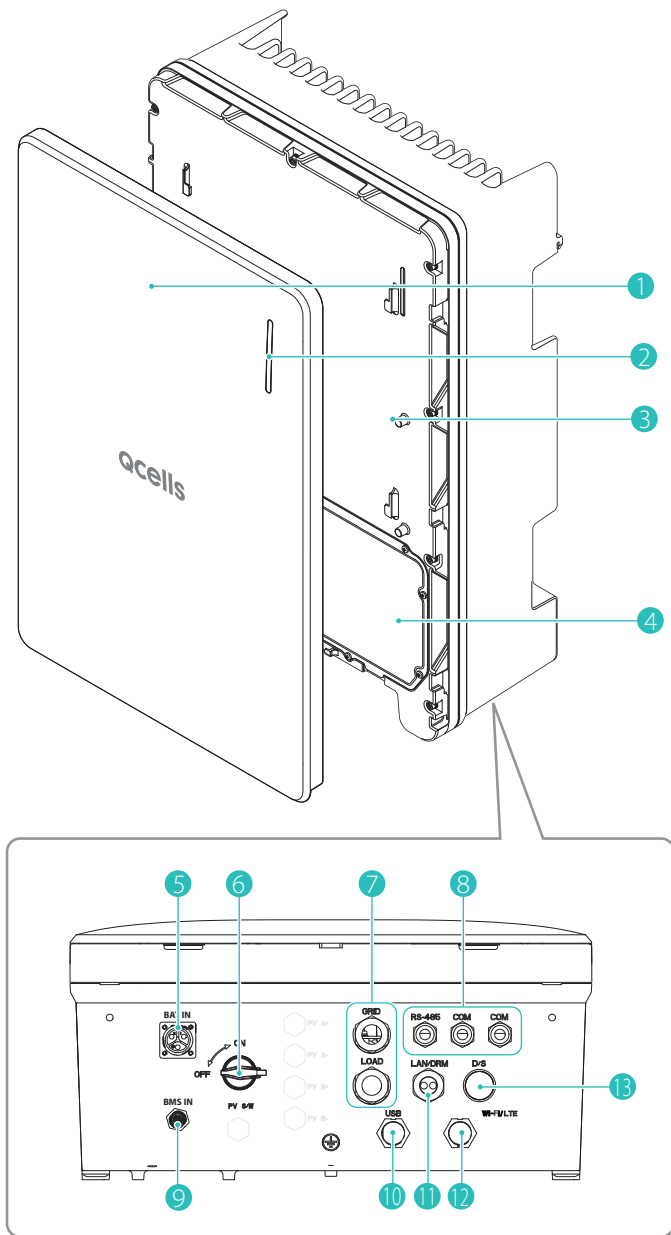

- | | |
|---------------------------|----------------------------|
| 1 Front cover | 8 Communication port |
| 2 LED indicator | 9 BMS Connector |
| 3 Inner cover | 10 USB Port |
| 4 Wiring cover | 11 LAN / DRM port |
| 5 Battery power connector | 12 Wi-Fi / LTE Dongle port |
| 6 PV switch | 13 Dark Start switch |
| 7 Grid and Load port | |

Note

For information about how to open the covers, refer to the installation manual.

3.2 Q.SAVE Overview

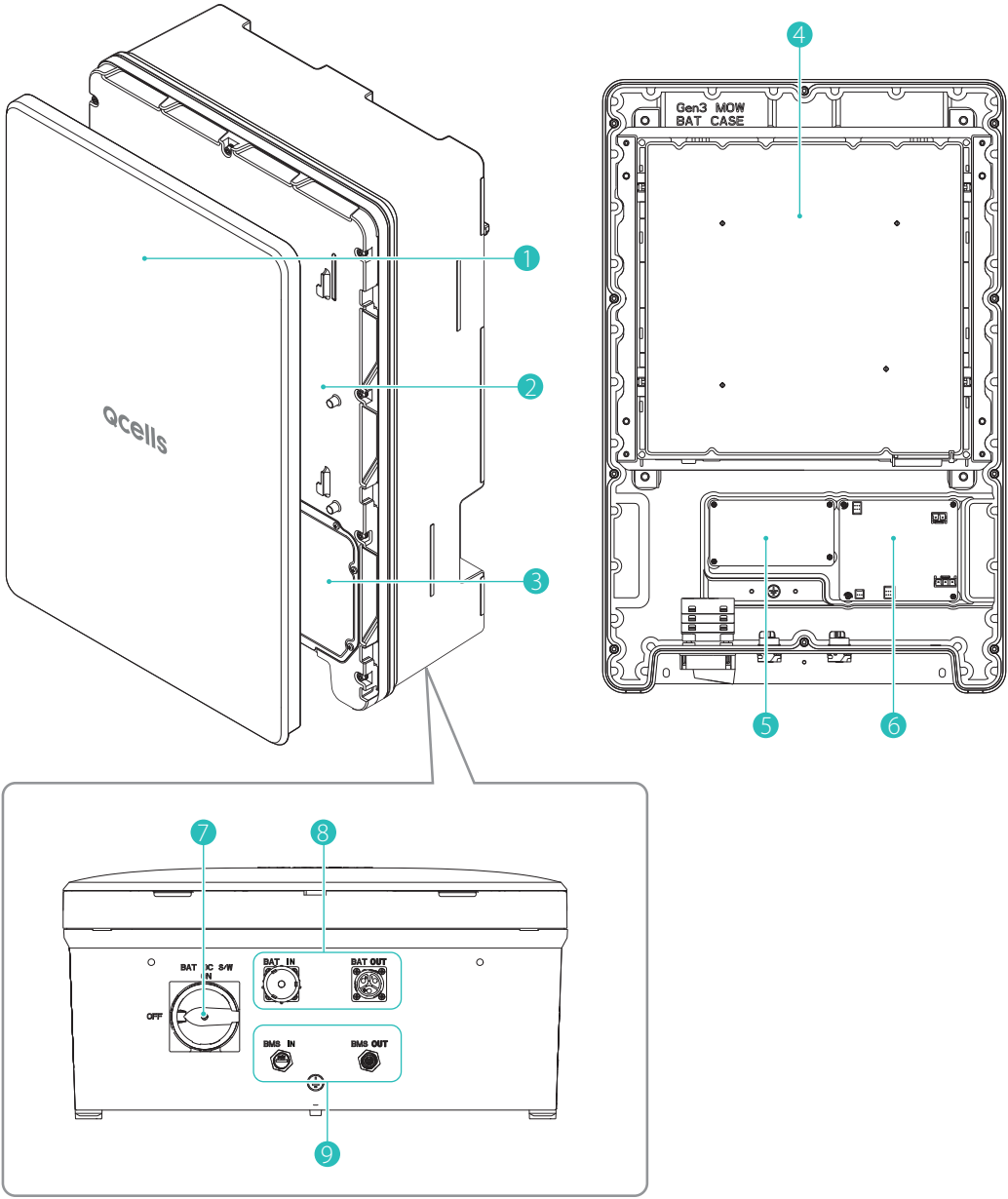

- 1 Front cover
- 2 Inner cover
- 3 Wiring cover
- 4 Battery module
- 5 Relay board
- 6 BMS board
- 7 Battery DC Switch
- 8 Battery Power Connector
- 9 BMS Connector

Product Description

3.3 Specifications

GENERAL PRODUCT INFORMATION		
Dimensions Inverter Module/ Battery Module (W × H × D)	[mm]	460 × 700 × 221, 238 (From Wall)
Weight Inverter Module/Battery Module	[kg]	33.9/61.1
Operating Temperature Range	[°C]	Q.VOLT: -20 to +60/Q.SAVE: -10 to +45
Relative Humidity	[%]	4 to 100 (Condensing)
Protection Degree/Class		IP65
Mounting		Wall-Mounted or Floor-Mounted Options
Max. Operation altitude	[m]	2,000
Cooling Method		Natural air cooling
Product Warranty/Performance Warranty		15/15 years
Noise Emissions		≤40 dB (A) @ 1m
Over Voltage Category		OVC II (DC)/OVC III (AC)
Communications		LAN, RS485, CAN, Wi-Fi (optional), LTE (optional)
Remote Monitoring		Web, Mobile & App
Software Update		Online update
Energy Management System		Integrated
Country of Manufacturer		Republic of Korea
GRID DATA (AC)		
Max. Apparent Power/Rated Output Power	[kVA/kW]	5/5
Nominal Voltage/Range	[V]	230/180 to 260
Nominal Grid Frequency/Range	[Hz]	50, 60/-5 Hz to +5 Hz
Feed-in Phase/Connection Phase		Single/Single
Nominal Current / Max. Current/ Max. Over-Current Protection	[A]	21.7/25/30
Power Factor Range		0.8 lagging to 0.8 leading
Total Harmonic Distortion	[%]	≤5
BACKUP POWER OUTPUT (ALTERNATING CURRENT)		
Connection Phase		Single
Rated Apparent Power/ Rated Power (Only Battery)	[kVA/kW]	3.3 to 4.5/3.3 to 4.5 @ 1 Battery Pack, 5/5 @ 2, 3 Battery Pack
Rated Apparent Power/ Rated Power (With PV)	[kVA/kW]	5.0/5.0 (max)
Rated Voltage	[V]	230
Rated Frequency	[Hz]	50, 60
Switch over Time to Backup Power		less than 0.1 seconds
Overload support		30 sec for 5.0 - 5.5 kVA, 20 sec for 5.5 - 6.0 kVA, 10 sec for 6.0 - 6.5 kVA @ 2, 3 Battery Pack and Off-grid

EFFICIENCY		
Max. Efficiency (Battery to Grid)	[%]	96.3
BATTERY UNIT (DC)		
Battery Technology		Lithium-ion NCA (Samsung SDI)
Battery Energy	[kWh]	6.8/13.7/20.5 (6.86 kWh/pack)
Battery Usable Energy	[kWh]	6.51/13.03/19.55
Max. Charge Power/Max. Discharge Power	[kW]	3.8/4.5 @ 1 Battery Pack, 5.0/5.0 @ 2, 3 Battery Pack
Converter Technology		Non-isolated
Rated Battery Voltage/Battery Voltage Range	[V _{DC}]	202.8/168.0 to 228.2
Maximum Charge/Discharge Current	[A]	16.9/20 (for each Q.SAVE unit)
Depth of Discharge (DoD)	[%]	95
CERTIFICATES AND APPROVALS		
Inverter Model Name		Q.VOLT A5S
Battery Model Name		Q.SAVE B6.8S
Certificates and Approvals		AS/NZS 4777.2:2020, CE, IEC 62109-1, IEC 62109-2, IEC 62040-1, IEC 62619, IEC 62477-1, EN 61000-6-2, EN 61000-6-3, IEC 60068.2-52, EN 60730-1ANNEX.H

4 Power On/Off

4.1 Turning On Q.HOME CORE

To turn on the Q.HOME CORE:

- 1 Turning on the AC circuit breaker.
- 2 Turning on the PV switch.

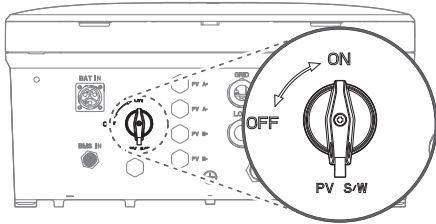

- 3 Turning on the battery DC switch.

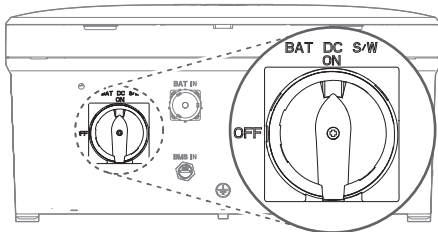

4.2 Using the Dark Start button

To turn on Q.HOME CORE when there are no PV and Grid:

Press the **Dark Start** button for about 10 seconds.

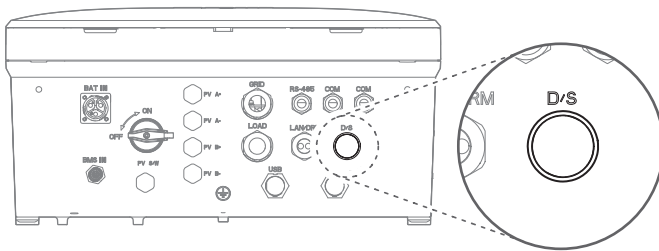

- Once the power is supplied and the LED turns blue, release the Dark Start button.
- Once the inverter enters the Off-grid mode and starts operation, the LED turns green.

4.3 Turning Off Q.HOME CORE



CAUTION

If the AC circuit breaker cannot remain switched on after commissioning (e.g. because the new meter has not yet been installed), the DC switch on the hybrid inverter must remain switched on to avoid deep discharge of the battery. Alternatively, the device can also be switched off completely.

To turn off the Q.HOME CORE:

- 1 Turning off the battery DC switch.

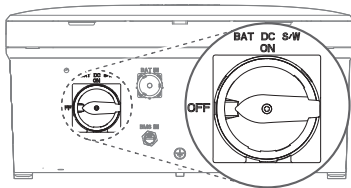

- 2 Turning off the PV switch.

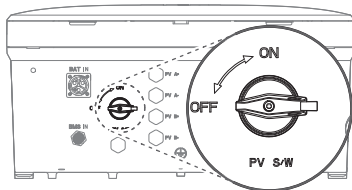

- 3 Turn off the AC circuit breaker in the junction box.



Note







After turning off the Q.HOME CORE, the DC and PV switches can be locked for safety.

For details about locking the DC and PV switches, see "16 Power Off" in the installation manual.

5 LED Status

After turning on the Q.HOME CORE, check the status of the LED indicator on the front.

The meanings of the LEDs by color and behavior are as follows:

LED Color	LED Behavior	Description
 Sky Blue	Solid	Charging or discharging in online mode
	Flashing	Standby in online mode
 Magenta	Solid	Charging or discharging in offline mode
	Flashing	Standby in offline mode
 Green	Solid	Charging or discharging in off-grid mode
	Flashing	Standby in off-grid mode
 Blue	Solid	All operations are paused
 Red	Solid	Error status
	Flashing	Reduced system access
 Yellow	Solid	Setup in progress
	Flashing	Connecting to the network
 White	Flashing	Upgrading firmware

6 Using the Q.OMMAND HOME App

6.1 Getting Started

Search and install Q.OMMAND HOME on the Apple AppStore or Google Play Store.



Android



iOS

The app runs with the following versions or higher. Check OS version of the mobile device.

- Android: 4.4 or higher
- iOS: 10.0 or higher

Log In

After you install and open the app, you have to select the location first and then log in.

- 1 Select the location.

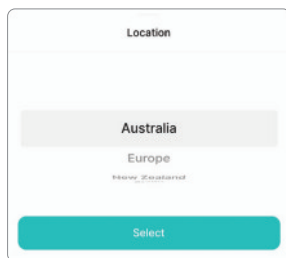

- 2 Tap **Select**.

- 3 Enter your ID and password and tap **Log in**, or use a social login.

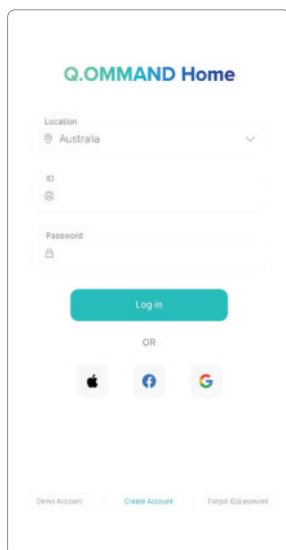

Note

If you do not have your account yet, select the location and tap **Create Account** at the bottom of the login screen to register for membership. You can also select a social login to register for membership.

Sign Up

- 1 Read and agree to the terms and conditions.
- 2 Tap **Accept and Continue**.
- 3 Enter your name, ID, password, email, phone number, Home ID, and Activation Code.
 - Home ID is a 9-digit household identification number provided by the installer. Please check your email or contact your installer if you have not received it.
 - Activation Code is a temporary password that has a 4-digit number created by the installer. Please check your email or contact your installer if you have not received it.
- 4 Tap **Create Account**.

Log Out

- 1 Tap **My Page** at the bottom right of the screen.
- 2 Tap **Logout**.

Find ID

- 1 Tap **Forgot ID/password** at the bottom of the login screen.
- 2 Tap **Find ID**.
- 3 Type the email address associated with your account, and tap **Find**.

Find Password

- 1 Tap **Forgot ID/password** at the bottom of the login screen.
- 2 Tap **Find Password**.
- 3 Type the ID and email address associated with your account, and tap **Find**.
- 4 A temporary password will be sent to the email address.

6.2 Main Menu Overview



- 1 **Home:** Provides a variety of real-time information about the system.
- 2 **Products:** Provides information and status of products and services.
- 3 **Energy:** Provides energy consumption/production data and graphs.
- 4 **My Page:** Provides account, app, installation settings, and FAQ.

6.3 Home Tab

Energy Flow Dashboard

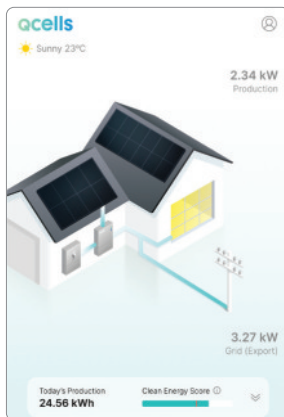

Updates the PV generation, battery charging/discharging, and grid system power information every 3 seconds. You can view the current household energy flow at a glance.

Product/Service Sliding Cards: show the overview and status of each product and service.



6.4 Products Tab

The **Products** tab provides each product's detailed information, status, and settings.

Setting the Energy Backup

The charging amount of the battery should be maintained above a certain range considering situations such as blackout. By setting the Energy Backup option, you can set the battery to discharge only up to the specific amount under normal circumstances and backup energy can be used when blackout occurs.

To set the energy backup:

- 1 Tap **Products** on the bottom of the screen.
- 2 Tap **Energy Storage**.
- 3 Tap **Battery**.
- 4 Tap **Battery Settings**.
- 5 Adjust the slider or choose the value (%) for the energy backup.

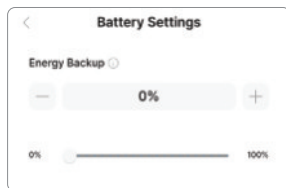

- 6 Tap **Save**.

Setting the Energy Mode

Available energy modes are the followings:

Self Consumption

- Controls the power autonomously.
- The electricity generated with PVs is first supplied to in-houseloads, and if there is any remaining electricity, it is used to charge the battery.

Time-based Mode

- Controls the electricity in accordance with the preset schedule.
- Controls the charging and discharging of batteries on an hourly basis .

To set the Time-based Mode:

- 1 Tap **Products** on the bottom of the screen.
- 2 Tap **Energy Storage**.
- 3 Tap **Inverter**.
- 4 Tap **Inverter Settings**.
- 5 Select **Time-based Mode**.

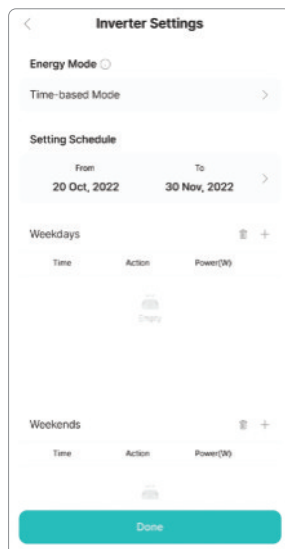

- 6 Choose a date and tap '+' button to add a schedule.

Available actions are the followings:

- None: Q.HOME CORE will be on standby, pausing all operations.
- Auto: Q.HOME CORE will operate in the same manner as Self Consumption.
- Inverter: By entering Power (-5000 W to 5000 W), you can control charging and discharging of batteries.
 - If you enter negative value(-5000 to -1), Q.HOME CORE will start charging from the grid.
 - If you enter positive value(1 to 5000), Q.HOME CORE will start discharging.

- 7 Tap **Done**.

6.5 Energy Tab



The Energy tab provides accumulated data and graphs of PV production, energy consumption, battery charge/discharge, Grid import/export, Battery SOC (State of Charge), and annual energy report.

- **Solar:** PV Produced Energy.
- **Home:** Consumed Energy.
- **Battery net energy:** Discharged Energy(POS) + Charged Energy(NEG)
- **Grid net energy:** Imported Energy(POS) + Exported Energy(NEG)
- **Battery SOC:** State of Charge (available for Day tab).

6.6 Changing the User Information

1 Tap **My Page** at the bottom right of the screen.

2 Tap **Account Settings**.

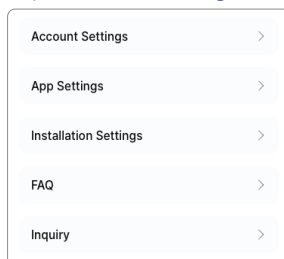

3 Change the desired item (E-mail, password, etc.).

4 Tap **Save**.

6.7 Viewing the Installation Information

1 Tap **My Page** at the bottom right of the screen.

2 Tap **Installation Settings**.

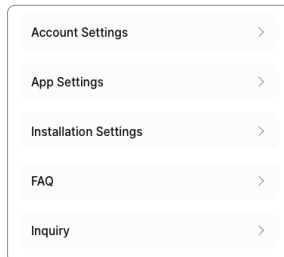

3 Select the desired tab.

- **General:** Provides the general information such as the serial number, Home ID, etc.
- **Installer:** Provides the installer contact information.
- **Address:** Provides the installation location.

6.8 Light Mode / Dark Mode Setting

1 Tap **My Page** at the bottom right of the screen.

2 Tap **App Settings**.

3 Tap **Display Theme**.

4 Select the desired mode.

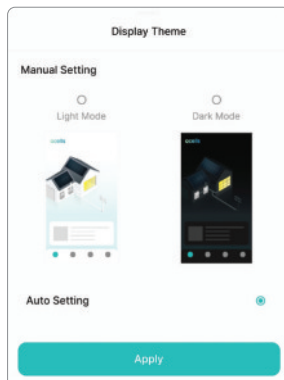

5 Tap **Apply**.

7 Operating Mode

7.1 ON-Grid Mode

Daytime On-Grid

- **PV Power > Load Power:** The PV power is preemptively supplied to the household load (Critical load + Main Load), and then it charges the battery. If PV energy remains, it is operated according to the operation mode as below.
 - **Self consumption mode:** The remaining PV energy is supplied to Grid.
 - **Time-based mode:** Controls the electricity in accordance with the preset schedule. Controls the charging and discharging of batteries on an hourly basis.
- **PV Power < Load Power:** If the PV power is less than the household load (Critical load + Main Load) power, the battery discharges to provide the short household load energy. If the PV + battery power is less than the load power, the short load power is supplied from the grid system.

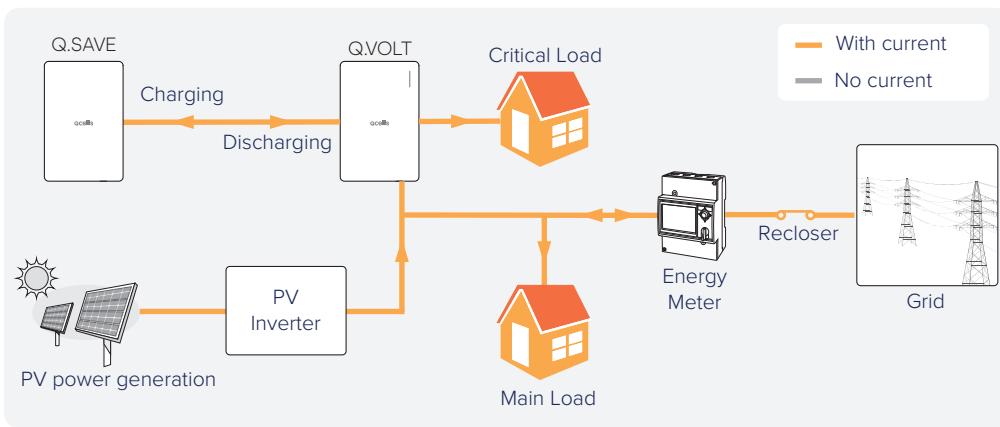

Nighttime On-Grid

While the battery discharges, it supplies energy to the load. If the battery power is not enough to supply energy to the household load (Critical load + Main Load), the short power is supplied from the grid system.

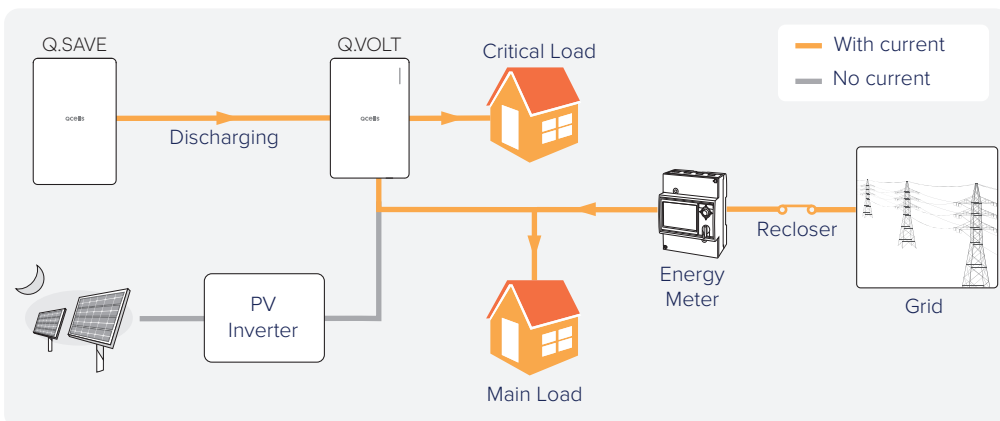

7.2 Off-Grid Mode

Daytime Off-Grid

- **PV Power > Load Power:** The PV power is preemptively supplied to the household load (Critical Load), and then it charges the battery. Then, when the battery is fully charged, the inverter lowers the PV power to generate as much as the household load (Critical load) power.
- **PV Power < Load Power:** If the PV power is less than the household load (Critical load + Main Load) power, the battery discharges to supply the short energy to the critical load. If PV + battery power is less than the load power, the inverter stops operating.

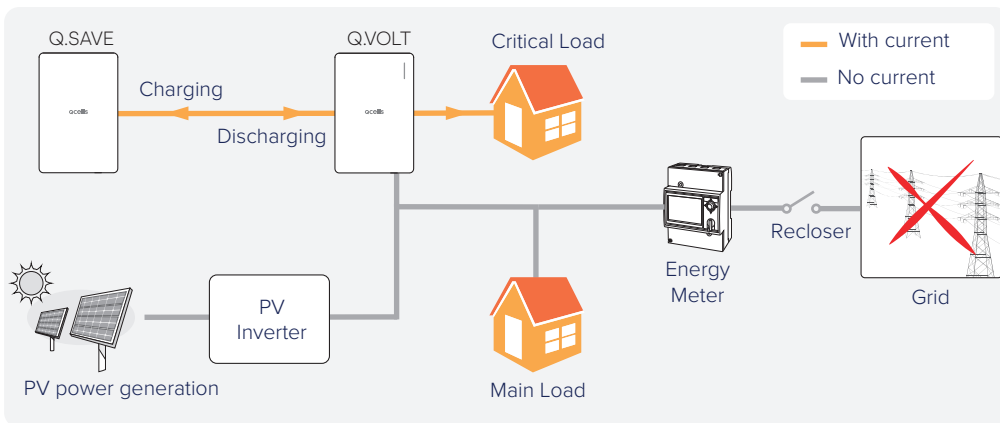

Nighttime Off-Grid

While the battery discharges, it supplies energy to the load. If the battery power is not enough to supply energy to the household load (Critical Load), the inverter stops operating.

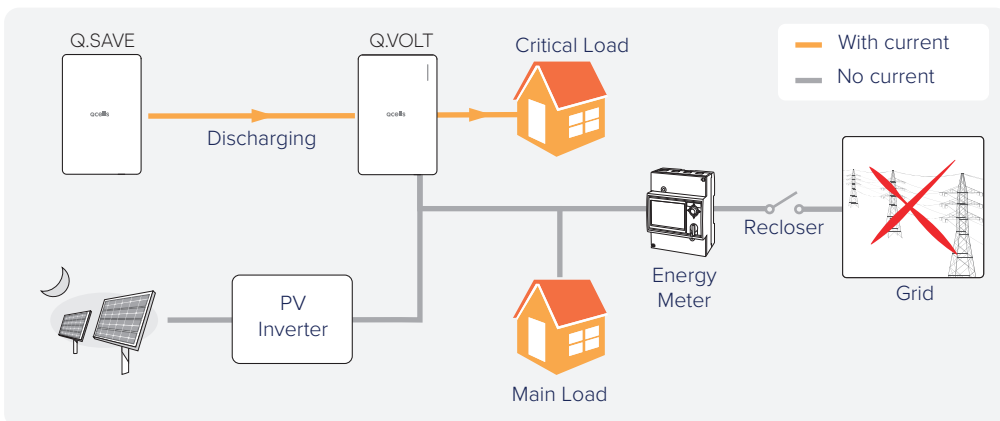

7.3 Seamless Transfer

- **On-grid → Off-Grid:** If disconnected due to a grid system failure during the on-grid operation, the inverter is disconnected from the grid system automatically and supplies power to the critical load seamlessly.
- **Off-grid → On-Grid:** If the grid system power is restored during the off-grid operation, the inverter is automatically connected to the grid system after a certain period and operates in the on-grid mode.

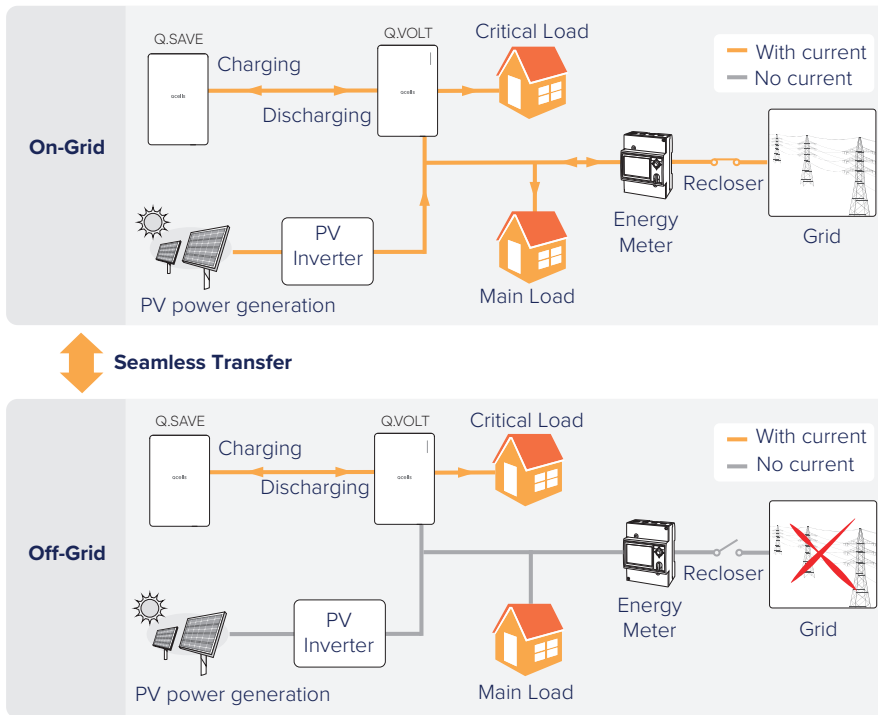

8 Features

8.1 Protection

Q.HOME Core has the following protective features to prevent equipment and persons from being damaged due to external accidents or equipment failure:

- Short circuit protection
- Over voltage/over current
- Over temperature
- Insulation resistance surveillance
- Residual current protection
- Anti-islanding protection

8.2 Power Derating

Q.HOME Core limits the output power on over-temperature to protect the inverter from overload or other potential errors. If the temperature does not drop beyond a certain period, the inverter stops its operation.

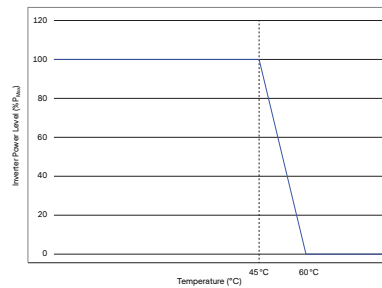

8.3 Overload Operation

Off Grid inverter output power
@ 2, 3 Battery Pack and 230V

Duration	Range
10s	6.5 - 6.5 kVA
20s	5.5 - 6.0 kVA
30s	5.0 - 5.5 kVA

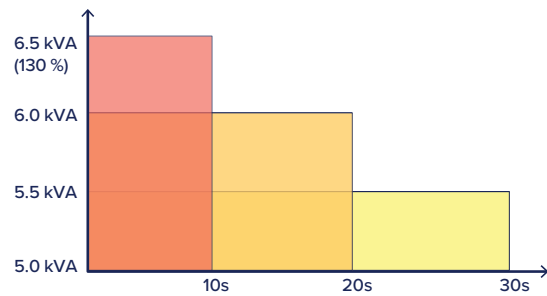

8.4 Power Quality Response

- Active Power Response:** The inverter supports the active power response mode according to the grid code to support the grid system.
 - Volt-Watt:** The input and output active powers are limited by the response curve according to the inverter operation mode (charging and discharging) and the grid system voltage. This response is supported only in Australia and New Zealand.

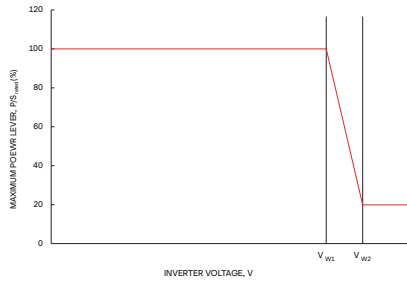
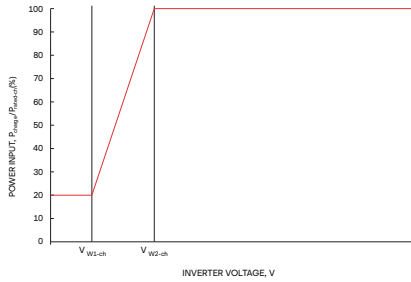

- Frequency-Watt:** The input and output active powers change by the response curve according to the inverter operation mode (charging and discharging) and the grid system frequency. This response is supported only in Australia, New Zealand, and Germany.

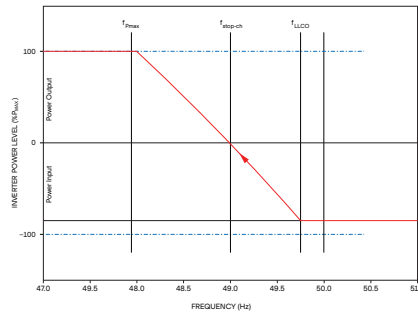
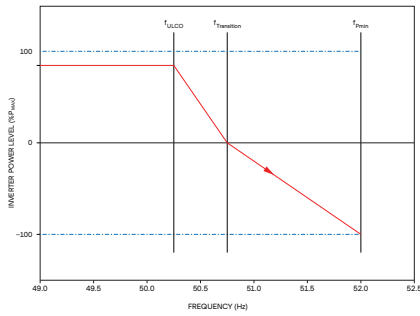

- Reactive Power Response:** The inverter supports the reactive power response mode according to the grid code to support the grid system.
 - Volt-var:** The inverter outputs the reactive power by the response curve according to the grid system voltage. This response is supported only in Australia and New Zealand.

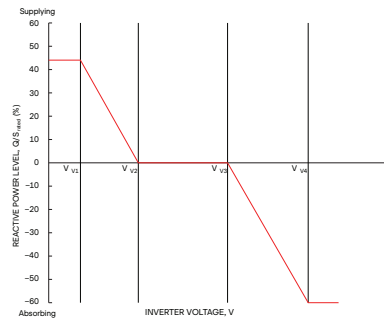

- Cos Φ (P) curve:** If the output power is generated 50% or higher, the inverter outputs the lagging reactive power according to the active power response curve. This response is supported only in Germany.

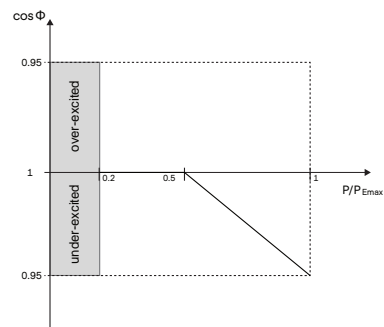

8.5 Battery Management

- **Backup SOC:** The minimum SOC that the battery maintains in order to supply power to the load in the case of Off grid.
 - Battery SOC < Backup SOC (On-grid mode): Q.HOME CORE does not discharge the battery but only performs charging operation.
- **Charge Management:** If the PV power is greater than the load power, the inverter charges the battery. If the battery SOC reaches 100%, the battery converter stops its operation not to be overcharged.
- **Discharge Management:** Discharge Management effectively prevents the battery from being damaged due to overcharge. If the battery SOC (State of Charge) reaches 5% or the Backup SOC, it limits the battery discharge.
- **Cell balancing:** If the inter-cell potential difference exceeds the threshold voltage, the PCS automatically starts cell balancing control to prevent the battery from damage due to the potential difference among battery cells.
- **Parallel Connection:** In the Q.SAVE parallel connection, internal module relays is not connected if voltages are different between each battery module. Then, the battery management system automatically controls charging/discharging power of each battery to achieve the identical Q.SAVE voltage. When the voltage of each module becomes equal, the internal relays are connected.

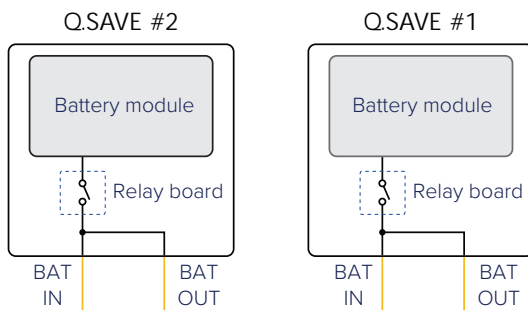

- **Power derating:** It limits the charging/discharging power on over-temperature/under-temperature to protect the battery from overload or other potential errors. If the temperature does not drop beyond a certain period, the BDC stops its operation.

8.6 Demand Response Modes (DRMS)

The inverter supports the DRM (Demand Response Mode) function as specified in AS/NZS 4777.2.

Mode	Description
DRM 0	The inverter is in the state of "Key-stop."
DRM 1	The import power from the grid is 0.
DRM 2	The import power from the grid is no more than 50 % of the rated power.
DRM 3	The import power from the grid is no more than 75 % of the rated power.
DRM 4	The import power from the grid is no more than 100 % of the rated power, but subject to the constraints from other active DRMs.
DRM 5	The export power from the grid is 0.
DRM 6	The export power from the grid is no more than 50 % of the rated power.
DRM 7	The export power from the grid is no more than 75 % of the rated power.
DRM 8	The export power from the grid is no more than 100 % of the rated power, but subject to the constraints from other active DRMs.

8.7 Dark Start

Dark Start feature allows you to turn on Q.HOME CORE when there are no PV and Grid:

For details about how to use the Dark Start, see "4.2 Using the Dark Start button" on page 12.

Note

In case of Dark Start, if the battery SOC is below 5%, Q.HOME CORE stops its operation and is turned off again.

9 Maintenance

9.1 Cleaning the Cover



CAUTION

Qualified Person Only!

If Q.HOME CORE is dirty, clean the enclosure, the enclosure cover and the LED using only clean water and a soft cloth.

Ensure that the Q.HOME CORE is free of dust, foliage and other dirty.

10 Full Warranty

Download the Q.HOME CORE warranty document from the Qcells web page or the following link (or the QR code), and make sure to read it carefully.





Hanwha Solutions Corp. Qcells

86 Cheonggyecheon-ro Jung-gu Seoul Korea 04541

Hanwha Q CELLS GmbH

Sonnenallee 17-21 Bitterfeld-Wolfen OT Thalheim, 06766 Germany

Hanwha Q CELLS Australia Pty Ltd

Suite 1, Level 1, 15 Blue Street, North Sydney NSW 2060 Australia

TEL +49 3494 6699 23333

WEB www.q-cells.eu

TEL +61 (0)2 9016 3033

WEB www.qcells.com/au/